

HYVA OIL TANKS



SIDE MOUNTED TANK

Hyva

type :

SM - 170L/134L - MP - MR

part number tank :

140 17 106

Page 1 / 1

working volume :

134 liters

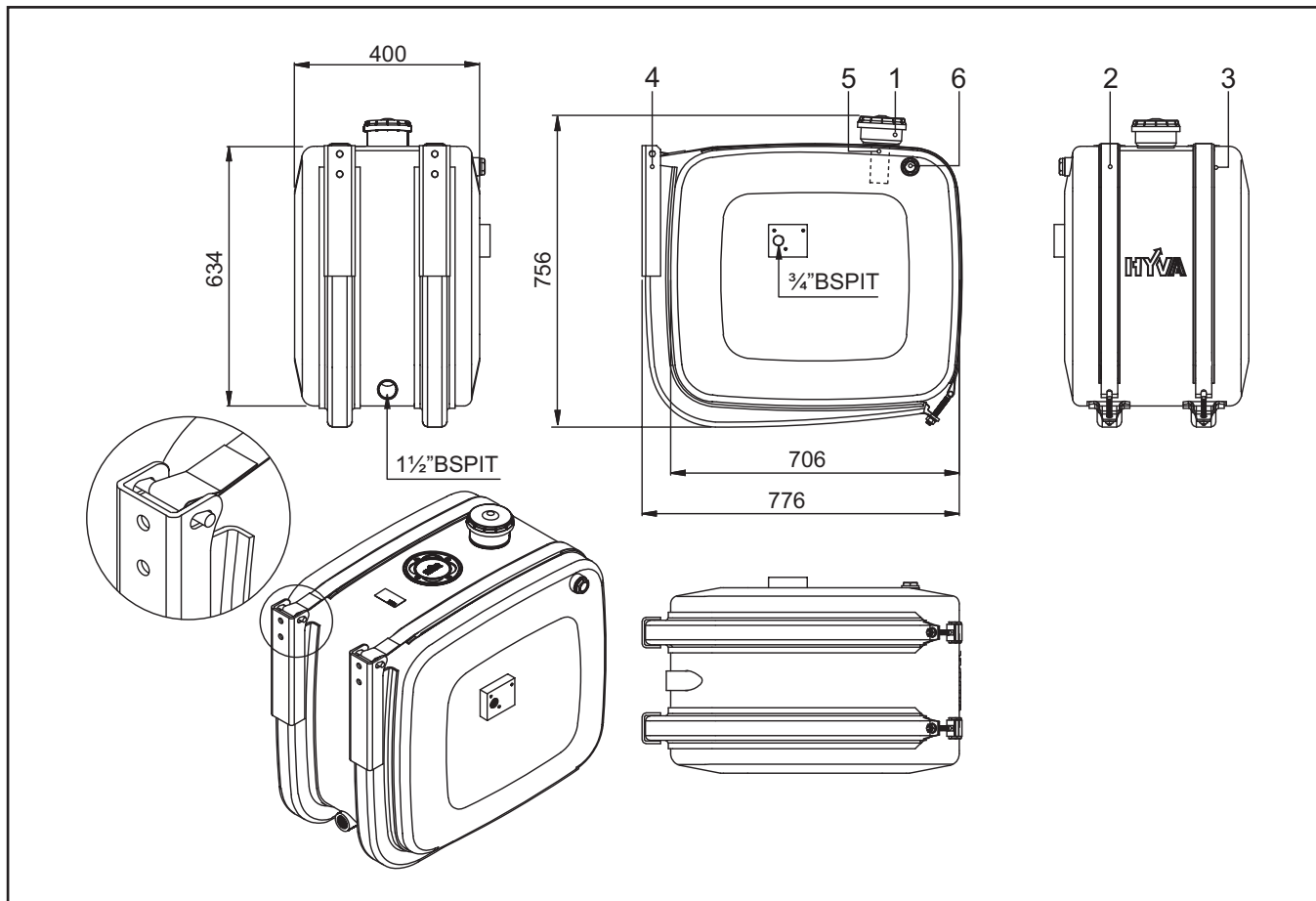

Part list

Pos.	Part no.	Description	Qty.
1	081 02 116	air breather filter	1
2	140 20 100	straps	2
3	140 20 118	kit for two supports 14020120	1
4	140 20 120	tank support	2

Spare Parts

Pos.	Part no.	Description	Qty.
5	081 02 117	air filter element	1
6	081 02 121	spy glass	1

Optional

147 80 303	return line filter kit	1
------------	------------------------	---

General information

Pay attention to the following points:

- Mount the tank according to the mounting instructions.
- Fill the tank with the recommended hydraulic oil to the centre of the spy glass (level indicator).
- Change the oil once a year.
- Replace the oil filter and air breather filter twice a year.
- Do not use the tank as a support or to stand on.
- Do not weld to the oil tank.

Mounting instructions

Before mounting the tank, check carefully whether all openings and connections are free of packaging tape, dirt or particles etc.

- Drill the top hole in the chassis as high as possible.
- Drill a second hole in the chassis according to the hole pattern of the support.
- Drill a third hole in the support and chassis at least 150 mm underneath the upper hole.
- Fix each tank support with 3 x M14 8.8 bolts and M14 washers.
- Mount the rubbers on the supports.
- Place the tank on top of the supports. Secure the straps to the top of the supports using the pins provided in the tank mounting kit. Make sure that the bended back-end of the strap (with 5 point welds) is facing upwards. See drawing detail.
- Place the strap rubber under the straps and mount the straps at the bottom of the support using the washers and nuts.
- Torque the straps to 20Nm by turning the bolts.
- Check the bolts for torque after 1000 km.

Specifications

Gross volume	: 170	Liters
Working volume	: 134	Liters
Weight tank	: 33,5	kg
Weight support	: 10	kg
Connections	: 1 1/2"	BSPIT suction
	: 3/4"	BSPIT mounting plate valve